

### Multi-tine Holder

In addition to the wide range of tines Wiedennmann offers various multi-tine holders to ensure an even higher operational efficiency. In the Nail Board for the 5 mm and 8 mm solid tines with a tine length of 65 or 135 mm allows you to mount up to 24 tines.

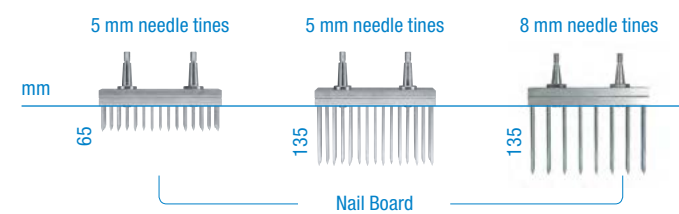

#### 1 Tine Holder

#### 2 QuickFit :

The nail board are easily and quickly mounted using the tine mounting and demounting system of the tine holder.

#### 3 Nail Board:

For exchanging tines the nail board is released through two screws, the tines are exchanged and the board is mounted again. Quick and easy.

TECHNICAL DATA	TERRA SPIKE XP 6	TERRA SPIKE XP 8
Working width in cm:	160	210
Weight in kg (app.):	960	1200
Working depth in cm with solid tines / hollow tines up to:	40 / 20	40 / 20
Dimensions L / W / H in cm (app.):	132 / 216 / 162	132 / 265 / 162
Mounting:	rear – 3-point cat. I + II	
Drive:	p.t.o. and 3 speed gear box	
QuickSet / QuickFit / PowerPack / VibraStop:	standard	standard
Tools:	solid spoons 5, 8, 12, 20, 25 mm / hollow spoons 12, 16, 20, 25 mm	
Rear roller:	standard	standard
Turf retainer:	optional	optional
Hydraulic depth adjustment:	optional	optional
Core swathboard:	optional	optional
Hydraulic rotary brush:	optional	optional
Set of ballast weights:	optional	optional
Bogey:	optional	optional
Nail board for solid tines of 5 / 8 mm:	optional	optional
Productivity with permanent operation in m <sup>2</sup> per hour with 20 mm solid tines and a square hole spacing of 130 mm:	@ 1,5 km/h – 60 holes/m <sup>2</sup> = 2400 m <sup>2</sup> /h	@ 1,5 km/h – 60 holes/m <sup>2</sup> = 3150 m <sup>2</sup> /h
Rendement m <sup>2</sup> /h en marche continue avec outils creux 20 mm et distance carrée entre trous de 65 mm :	@ 0,75 km/h – 240 holes/m <sup>2</sup> = 1200 m <sup>2</sup> /h	@ 0,75 km/h – 240 holes/m <sup>2</sup> = 1575 m <sup>2</sup> /h

Descriptions and images are not binding. Construction and design are subject to modifications

## From the inventors of professional turf maintenance.

As a manufacturer of professional specialised machines, our entire passion is applied to turf. No matter whether on the golf course, in large sport stadiums around the world, or in the municipalities – the care of professionally employed lawns and turf are especially close to our heart. We have made this passion our profession, and thanks to our experience and know-how, we have also expanded to artificial turf maintenance and dirt and snow removal.

Our high-quality accessory equipment for compact tractors and municipal equipment carriers deliver complete solutions for turf regeneration as well as the collection or removal of grass and leaves. Highly-specific mowing machines, turf sweepers, sweepers for snow and dirt, snow raker blades and winter service spreading machines round off the product range and convince our customers by their efficiency and practicability. No matter what the season, no matter what the purpose – as professionals, we know what professionals need.



## TERRA SPIKE® XP

For deep aeration and removal of compactions up to 40 cm depth

- Central tine and depth adjustment
- Integrated absorbing-, tine mounting and dismounting system
- Complete line of tools and rear accessories

Further information:

Wiedennmann GmbH  
Am Bahnhof | 89192 Rammingen | GERMANY  
Phone +49 7345 953-0 | Fax +49 7345 953-233  
info@wiedennmann.com

[www.wiedennmann.com](http://www.wiedennmann.com)



We love turf. [www.wiedennmann.com](http://www.wiedennmann.com)

## For deep aeration and removal of compactions up to 40 cm depth.

Regular deep spiking and deep aeration is the prerequisite for a healthy growth of roots. After decompacting the ground, the roots can penetrate deeper into the ground and thus will make better use of water and nutrients. The water and air circulation will be improved, thatch will be removed and the shearing strength will be increased.

Often there is only very little time available for performing this job, which is especially important for the quality of your turf. Therefore, a high productivity with both an excellent quality of work and an easy operation are important criteria for you when selecting the machine to be used? Well, the TERRA SPIKE® XP is the ideal machine for you.

The TERRA SPIKE® XP is operated on golf greens, fairways and sport grounds. Prior to developing the TERRA SPIKE® XP the engineers from Wiedenmann listened carefully to the green keepers and groundsman and made their requirements the basis for the conception of the TERRA SPIKE® XP. Using most sophisticated 3D CAD technology the requirements of these practical users were realized in the TERRA SPIKE® XP. Technical reliability and a long service life of the machine were further criteria during the development stage. The individual components were selected and tested carefully. After completing the development stage the TERRA SPIKE® XP had to undergo a long test stage, proving in a rough permanent field operation that it meets all requirements of the development target. Another important request of the users was the requirement of a multiple utility of the TERRA SPIKE® XP.

This requirement has been met with the System TERRA SPIKE®. For the application along with the TERRA SPIKE® XP there is a wide range of tools and rear attachments available, allowing to expand the TERRA SPIKE® XP into a multi-functional machine which can be operated over the whole year. This brochure gives you detailed information about the various options for operating and applying the TERRA SPIKE®

### Quicker – Easier – More Efficient

TERRA SPIKE® XP – the new dimension of deep aeration which treats your turf gently. When you have mounted the TERRA SPIKE® XP to your tractor and have lifted it for the first time, you will be surprised at how easy it works. The reason for that is the especially compact direct attachment of the TERRA SPIKE® XP, which reduces the necessary lifting power considerably. Find out how quick and easily both the working depth and the tine entry angle can be adjusted using the QuickSet. The wide adjustment range of the tine entry angle from 90° up to 65°, which is adjusted centrally through a crank, allows the optimal adjustment of the spiking intensity to the respective ground conditions and the extent of soil compactions. The robust 3-speed gear allows to set the desired hole spacing precisely synchronized to the respective driving speed.

The fact that a firm fit of the tine in the tine holder and still a quick exchange of tines is no contradiction is demonstrated by the QuickFit. This technical detail solution will convince you as well.

## Benefits:



**Individual adjustment** of the loosening angle to ground conditions, tool-free from 90° to 65°.



**Fast tine replacement** with QuickFit, the simple tine fitting and removal system.

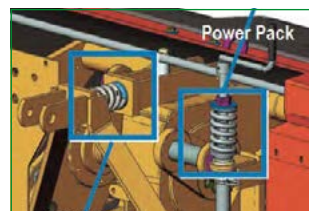

**Protection against damage** VibraStop/PowerPack form an efficient damping system to prevent jolting and vibration.



**Tool-free adjustment** of the tine angle and the working depth with the QuickSet feature.

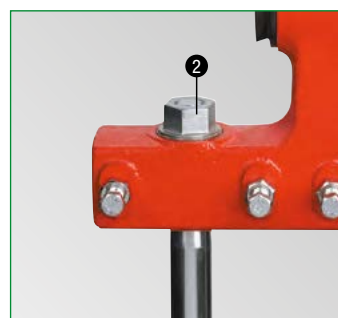
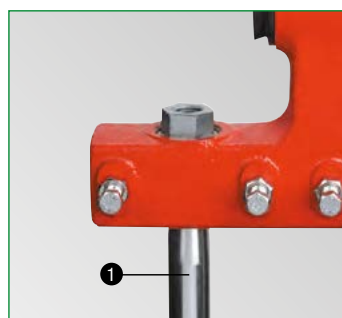

### QuickFit

The integrated system for mounting and demounting tines allows the quick and trouble-free mounting of the conical 20 mm and 25 mm tines.

### Mounting of Tines

- 1 Hand-tighten the tine from below into the tine holder.
- 2 Screw the lock nut tight from above. The tine is now safely tightened in the conical tine holder.

### Dismounting

- 2 Turn the lock nut in the opposite direction, which will press the tine out of the cone.
- 1 Afterwards, turn out the tine manually.

### Tine Program for Every Application

A complete range of solid tines with diameters of 5, 8, 12, 20 and 25 mm, as well as hollow tines with diameters of 12, 16, 20 and 25 mm, let the TERRA SPIKE® XP master every job. Using the 5 mm needle tines you can achieve up to 3,700 holes per m<sup>2</sup>. These are optimal prerequisites for light aeration or for preparing the ground for overseeding.

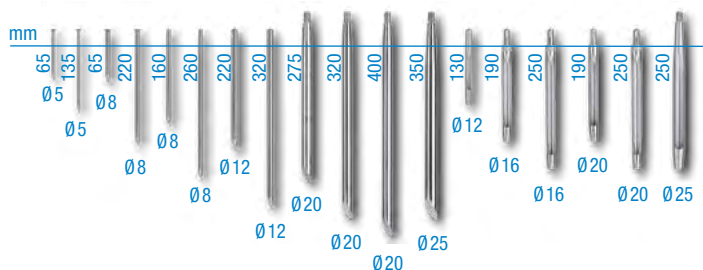

### Change Speed Gear

Extremely robust change-speed gear allows to set the desired hole count in accordance with the operating speed and number of tines.

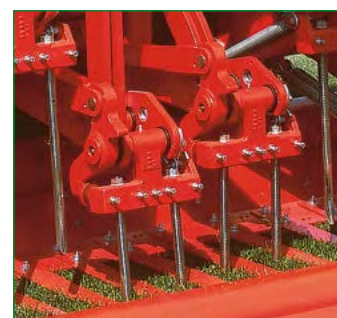

### Tine Holders

The robust tine holders with largely dimensioned bearings and integrated grease reservoirs even withstand extreme conditions, such as impact stresses, dirt and sand.

### QuickSet

Central, tool-free and quick adjustment of tine entry angle (90° up to 65°) and working depth. By means of just one central crank you can easily and quickly make these adjustments which are important for the working quality, whichever tine length you have mounted or whether the tine is new or used. If desired, the working depth can also be adjusted hydraulically from the driver's seat. In case of frequently changing ground conditions this allows to adjust the working depth of the TERRA SPIKE® XP quickly and during the operation.

### 1 Central Depth Adjustment

You'll be surprised at how quickly and easily the working depth of the TERRA SPIKE® XP can be set. Transfer the length of the tines you have mounted to the adjustable depth pointer, then set the desired working depth by means of the central depth adjustment crank. Finished. There's no quicker and easier way.



### 2 Central Adjustment of Angle

Crank with integrated PowerPack for the central, quick and tool-free adjustment of the entry angle of the tines.

Achieve different spiking intensities by adjusting the entry angle of the tines.

Entry angle	Pivot angle	Stroke (mm)	Depth (mm)
90°	6°	28	200
85°	13°	50	200
80°	19°	65	200
75°	25°	70	200

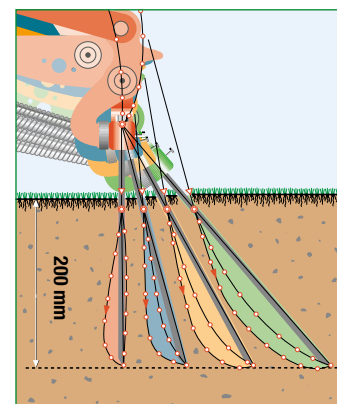

### VibraStop / PowerPack

Deep aeration and loosening is tough work, both for man and machine. If, for example, a tine makes contact with a stone during operation, the tine must lift the entire machine within a fraction of a second in order to overcome this obstacle. The jolts and vibrations that inevitably occur when this happens adversely affect not only the deep aerifier, but also the tractor and the tractor driver in the form of damaging jolts and vibrations. Consequently the quality of work suffers.

To eliminate this fundamental drawback, Wiedenmann has developed two independently operating, exclusive damping systems – VibraStop and PowerPack. Together, they absorb perfectly all jolts and vibrations caused by extreme compaction or stones. The result is unrivalled smoothness of running with a minimum of strain on the driver, tractor, deep aerifier and tools.

### VibraStop PowerPack

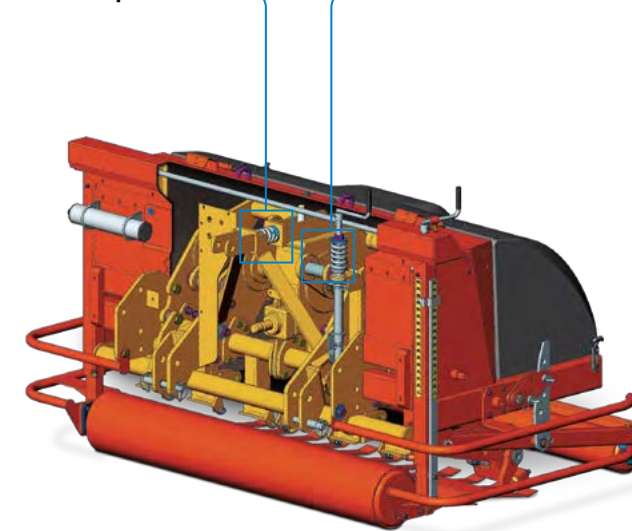

### Other machines on the market

The tine strikes an obstacle in the soil. The resulting impact is transmitted undamped to the deep aerifier, the tractor and the tractor driver with damaging effect.

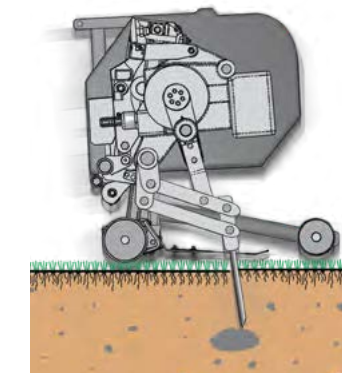

### TERRA SPIKE® XP

The tine strikes the same obstacle in the soil. The VibraStop and PowerPack damping systems are instantly activated, and the resulting impact is absorbed. This way, the load on the deep aerifier and tractor is reduced to an almost negligible level.

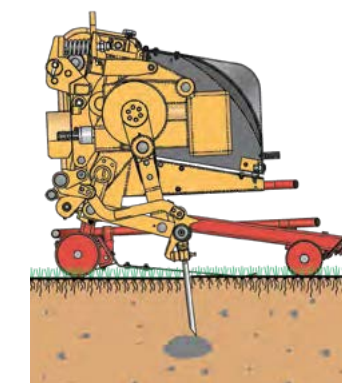

### Swathboard

When using hollow tines the cores can be deposited in rows by means of the optional swathboard. This makes the subsequent collection of the cores much easier.

